



**Güvenliğiniz
En Üst Nuktada**

**The Most
Secure Doors**

İÇİNDEKİLER CONTENTS

8

Exclusive Serisi
Exclusive Doors

18

Lüks Tabii Kabartma Serisi
Luxury Natural Embossed Doors

42

Laminoks Serisi
Laminox Doors

56

PVC Rustik Serisi
PVC Rustic Doors

58

Silindir Serisi
Cylinder Doors

20

Termo Serisi
Thermo Doors

22

Taş Serisi
Slim Natural Stone Doors

24

Alüminyum Kompozit Serisi
Aluminum Composite Doors

60

Sac Serisi
Full Metal Doors

62

Acil Çıkış Kapısı Serisi
Emergency Exit Doors

66

Tesisat Şaft Kapağı Serisi
Electrical Room Door

28

PVC Kabartma Serisi
PVC Embossed Doors

32

Laminant Serisi
Laminate Doors

36

Ultralam Serisi
Ultralam Doors

68

Villa Serisi
Main Entrance Doors

72

Teknik Detaylar
Technical Details

76

Aksesuar
Accessories



A EX-01

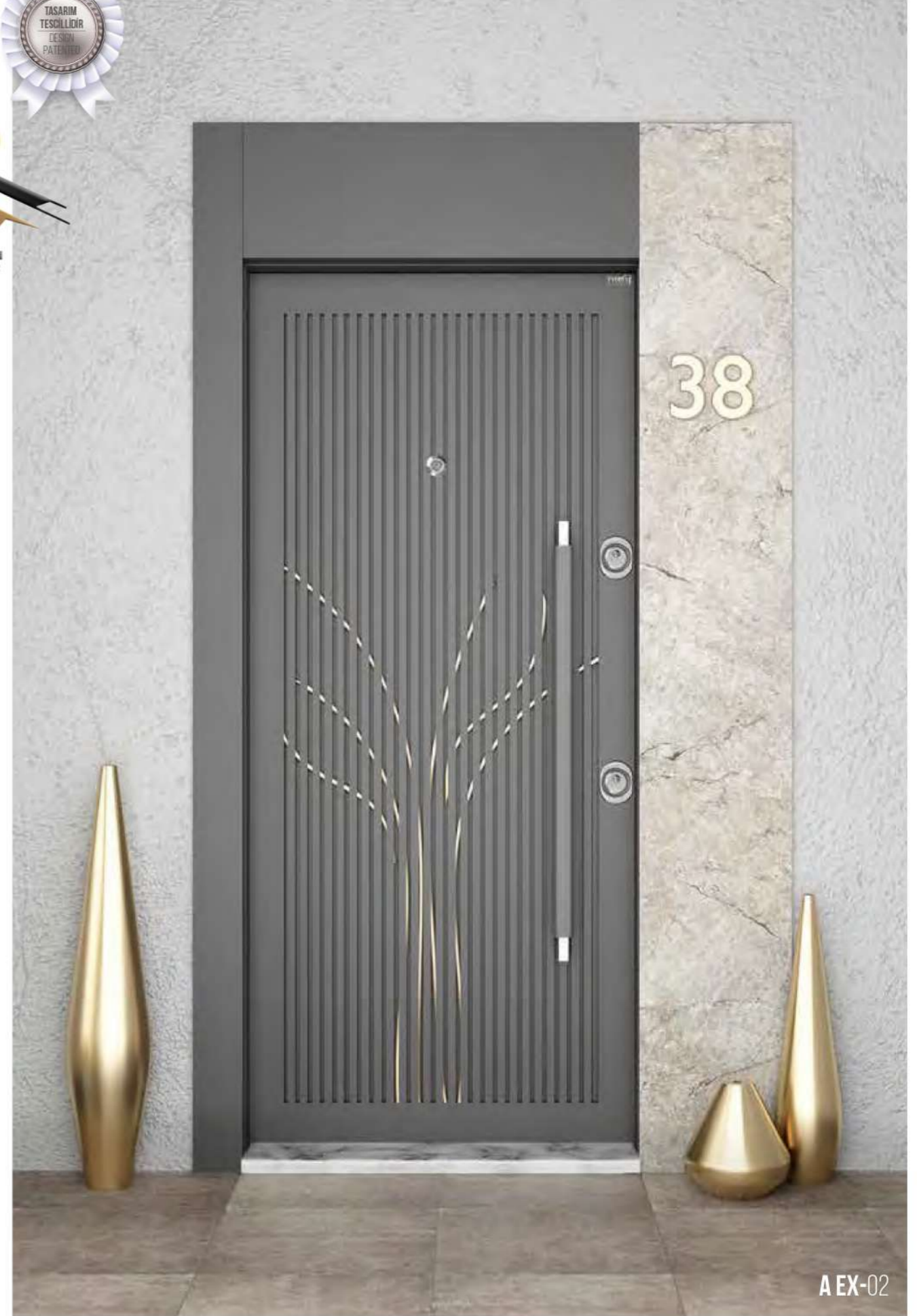

A EX-02



A EX-03



A EX-04



A EX-05



A EX-06



A EX-07



35

A EX-08



A EX-09

A EX-10

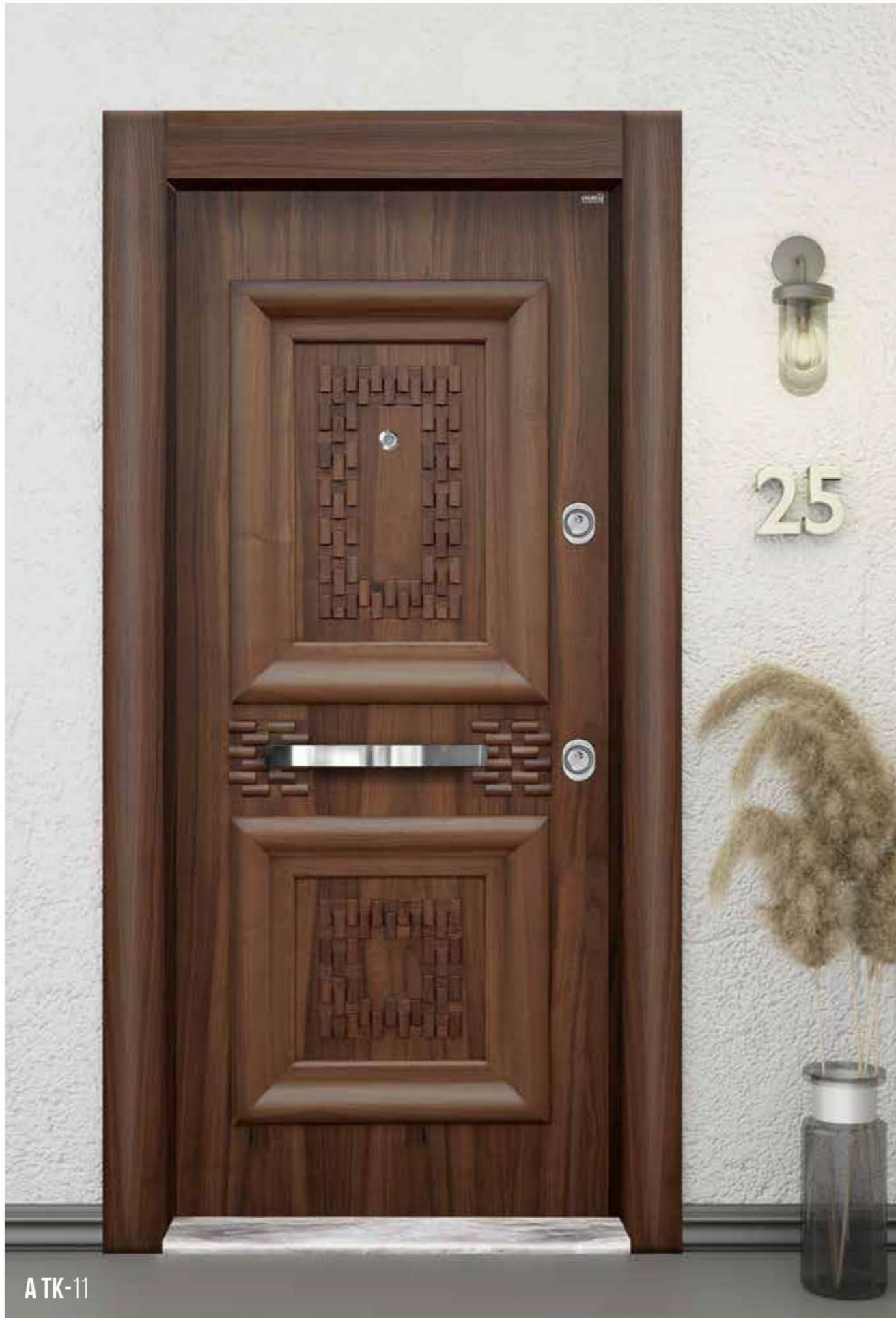

A TK-11

A TK-12

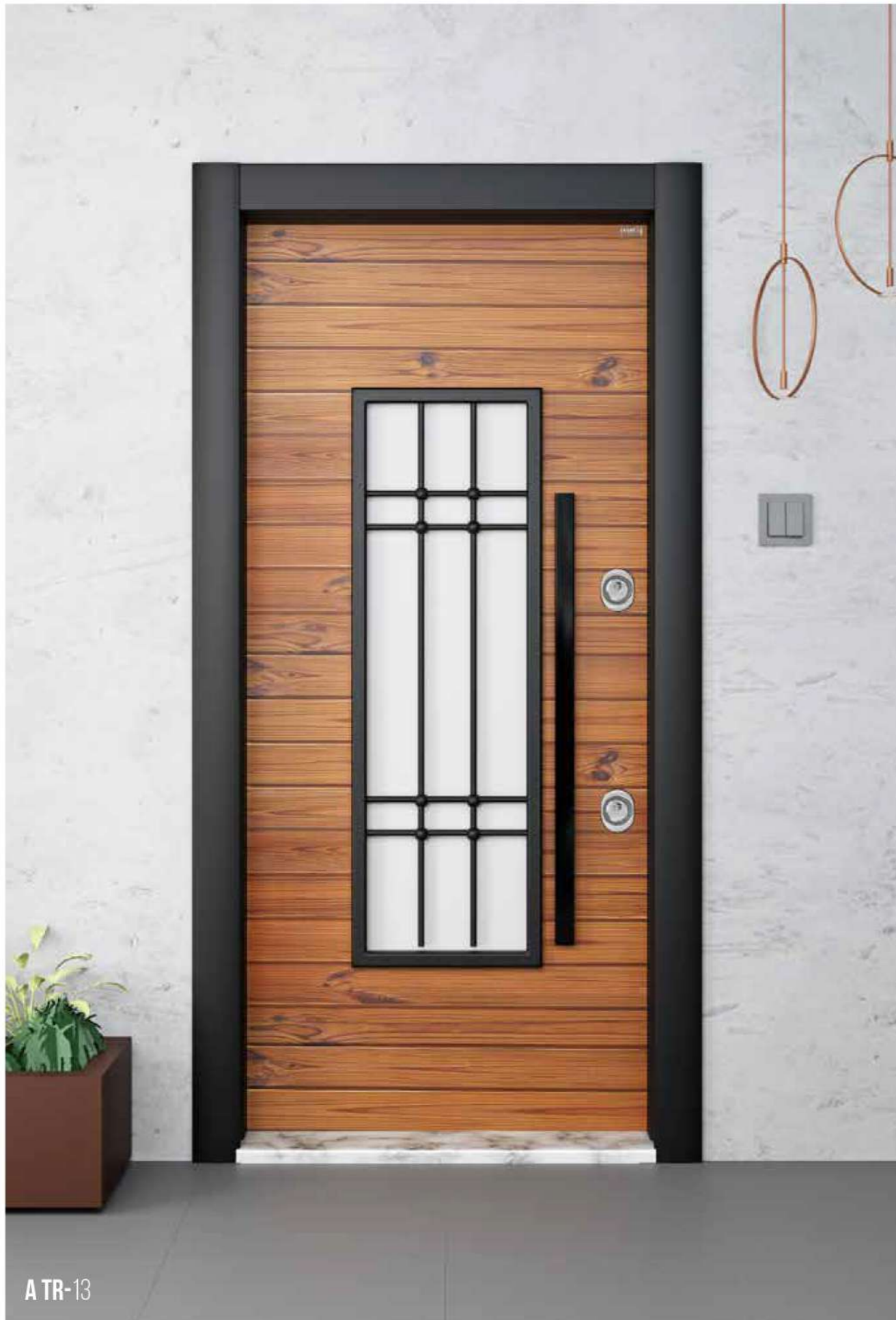

A TR-13



A TR-14



A TR-15



A TR-16



A TR-17



ATS-18



ATS-19



ATS-20



ATS-21



ATS-22



A AK-23



A AK-24



A AK-25



A AK-26



A AK-27



A AK-28



A AK-29



A AK-30



A AK-31



A AK-32



A PV-33



A PV-34



A PV-35



A PV-36



A PV-37



A PV-38



A PV-39



A PV-42



A PV-43



A PV-40



A PV-41



A PV-44



A PV-45



ALA-46

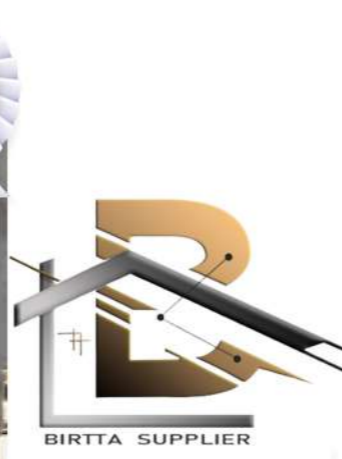

ALA-47



ALA-48



ALA-49



ALA-50



ALA-51



ALA-52



ALA-53



ALA-54



ALA-55



A UL-57



A UL-58



A UL-59



A UL-60



A UL-61



A UL-62



A UL-65



A UL-66



A UL-63



A UL-64



A UL-67



A UL-68



A UL-69



A UL-70



A UL-71



A UL-72



A UL-73



ALX-74



ALX-75



ALX-76



ALX-77



ALX-78



ALX-80



ALX-81

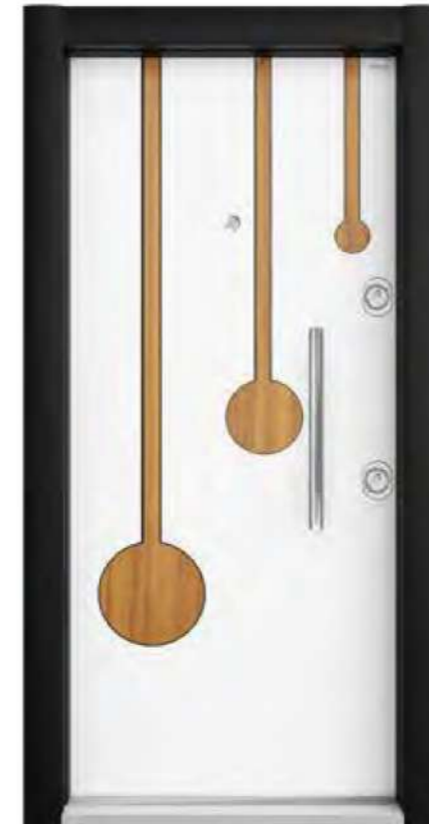

ALX-82



ALX-83



ALX-84



ALX-85



ALX-88



ALX-89



ALX-86



ALX-87



ALX-90

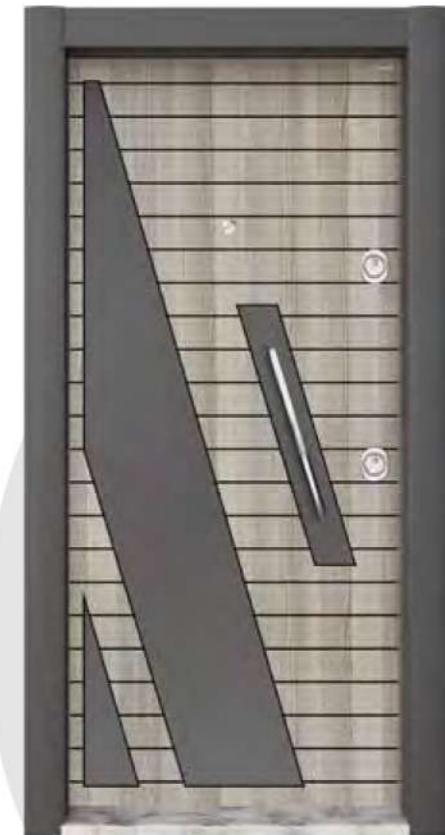

ALX-91



ALX-92



ALX-93



ALX-96



ALX-97



ALX-94



ALX-95



ALX-98



ALX-99

Laminoks Çift Renk | Laminoks

Laminoks Çift Renk | Laminoks



ALX-100



ALX-101

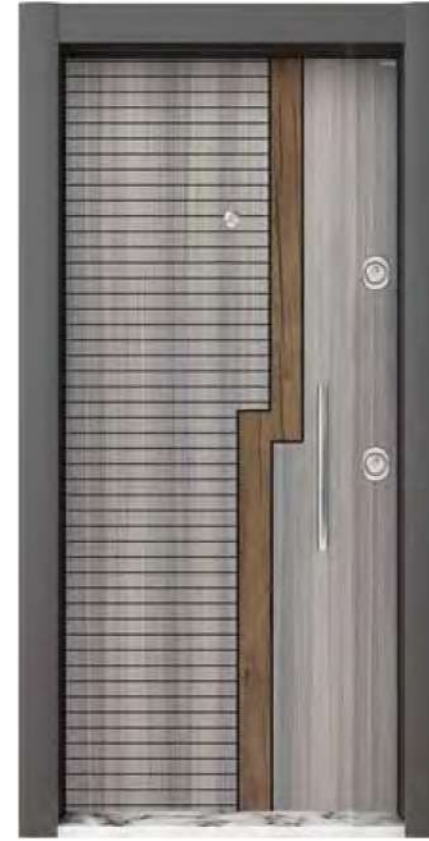

ALX-104



ALX-105



ALX-102



ALX-103



ALX-106



ALX-107



ALX-108



ALX-109



ALX-110



ALX-111



ALX-112



ALX-113



ALX-114



ALX-117

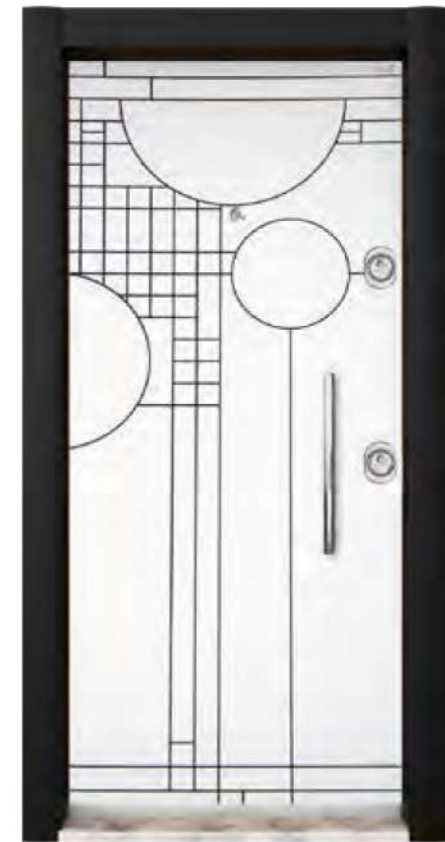

ALX-118



ALX-115



ALX-116



ALX-119



ALX-120



A PR-121



A PR-122



A PR-123



A PR-124



A PR-125

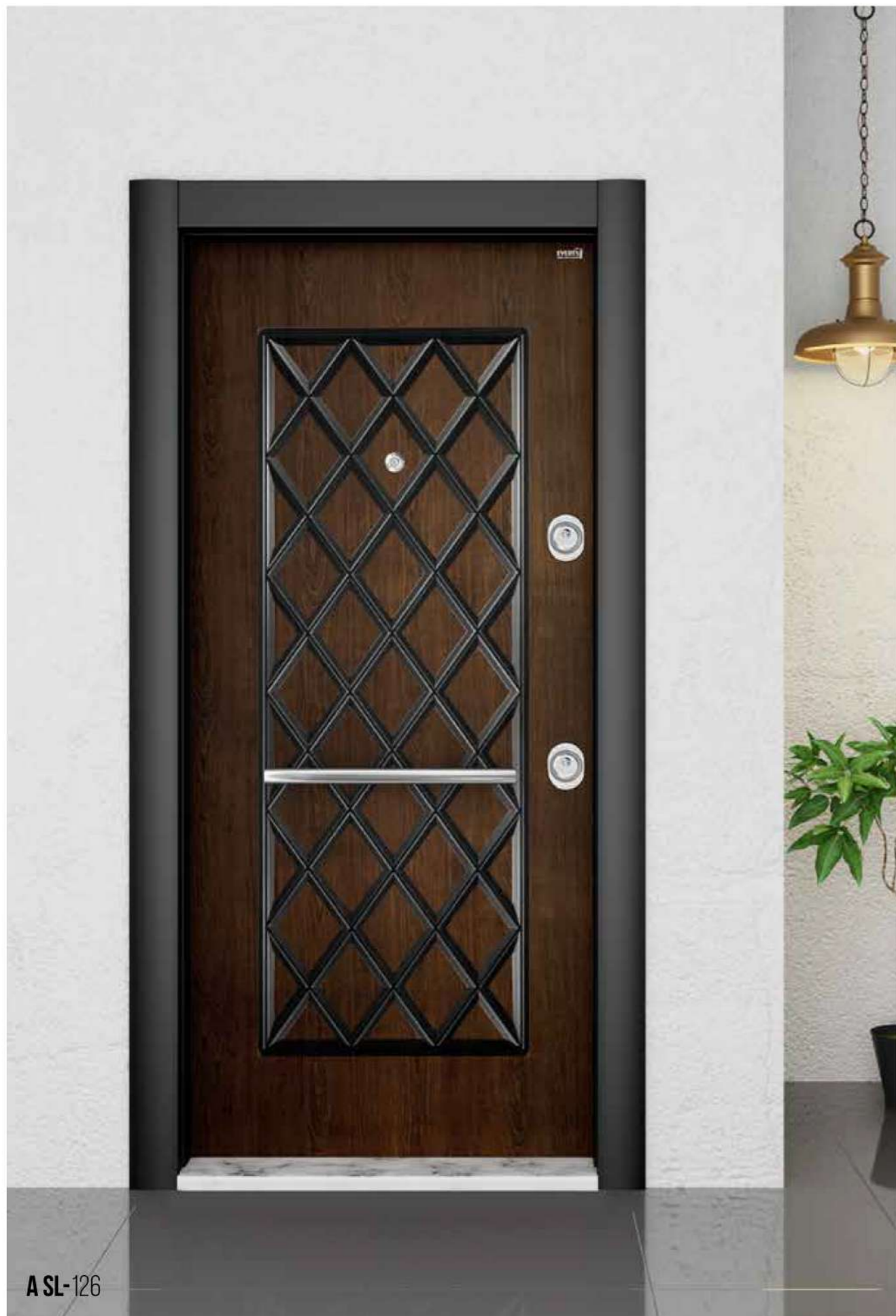

A SL-126



A SL-127



A SL-128



A SL-129



A SL-130

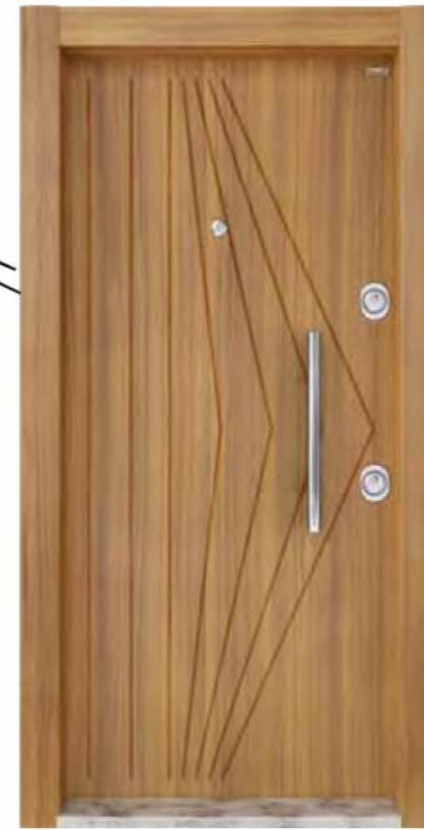



A FR-137



A FR-138



A FR-139



A FR-140



A FR-141



A FR-143



A FR-144



A FR-142



A FR-145



A FR-146



A SF-147

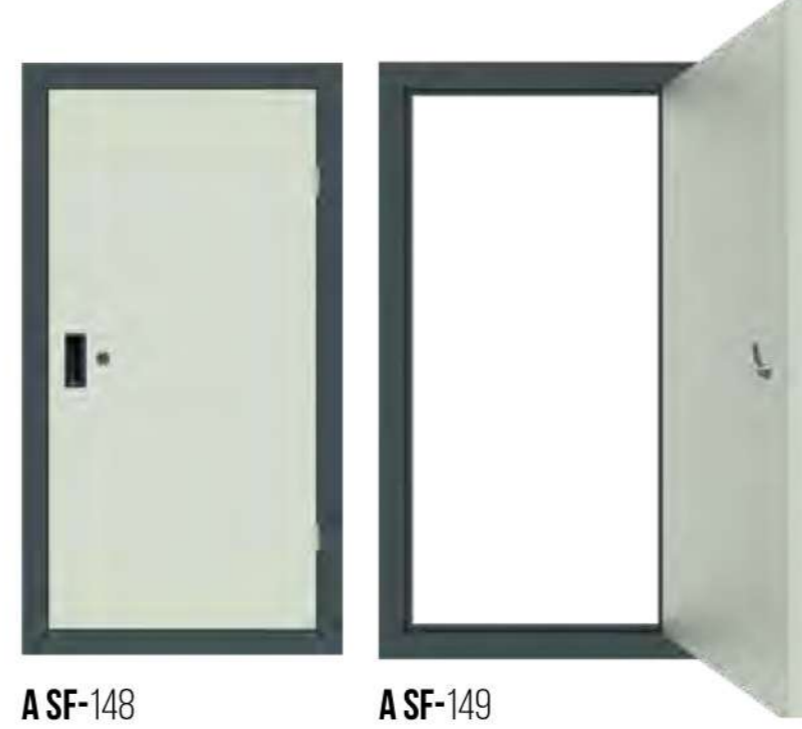

A SF-148

A SF-149



A SF-150

A SF-151



AVL-152



AVL-153



AVL-154

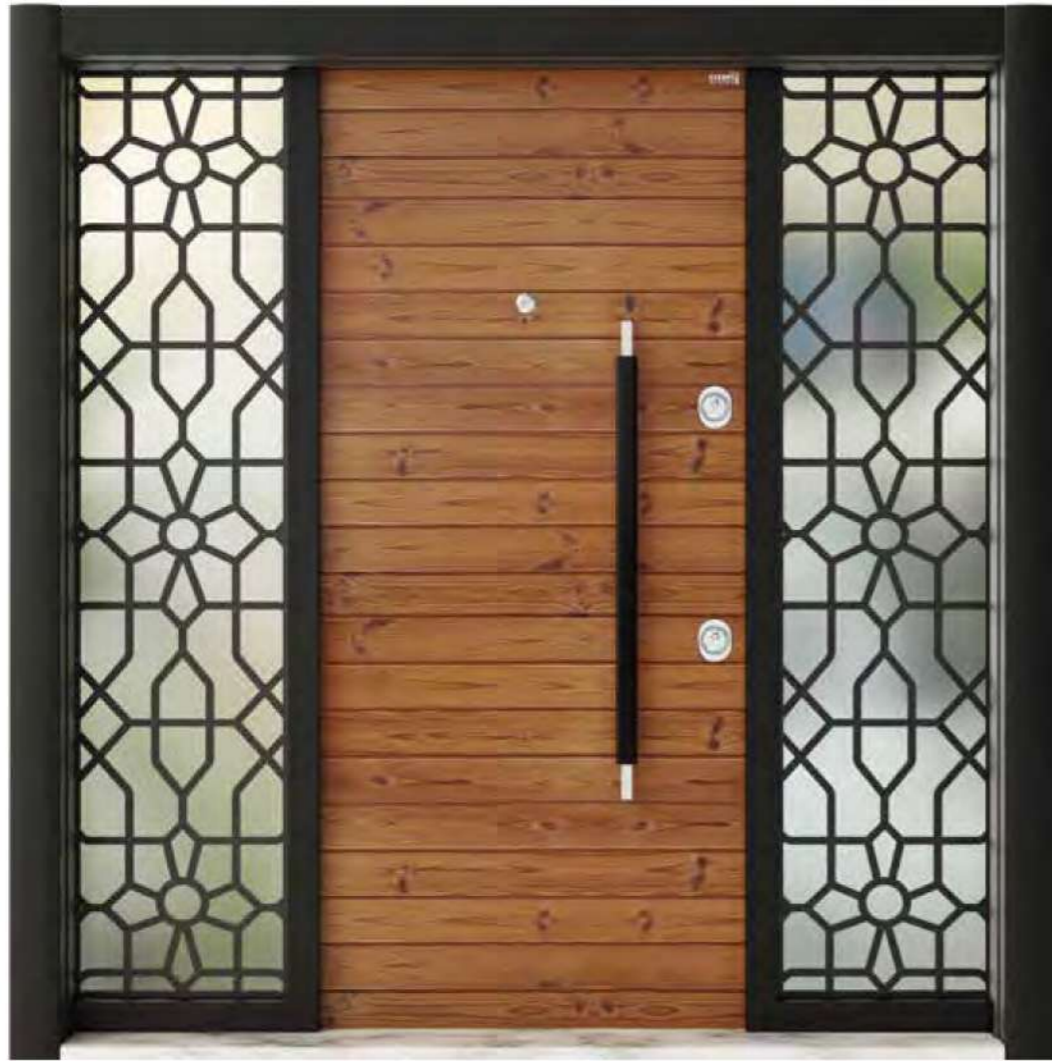

A VL-155

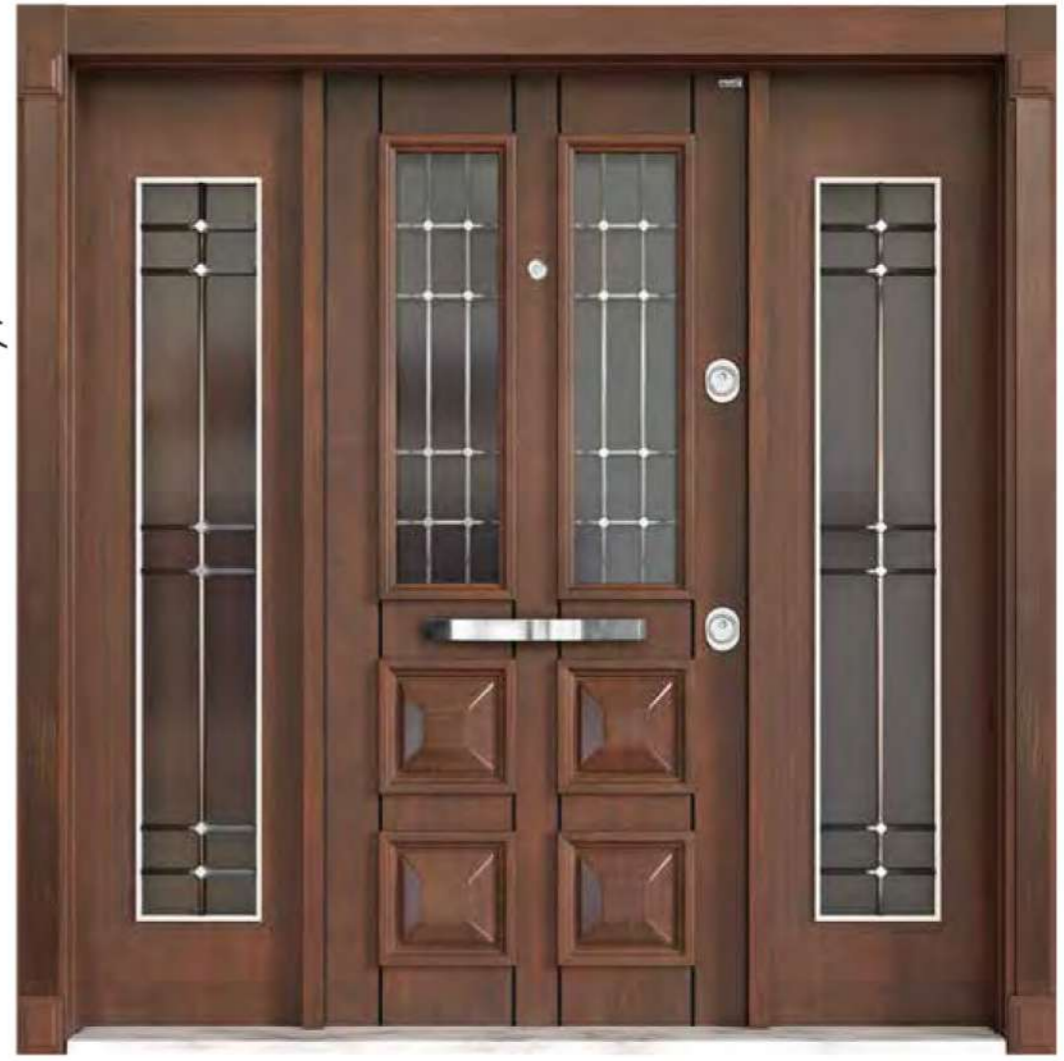

A VL-158

Villa Serisi | Main Entrance Doors



A VL-156

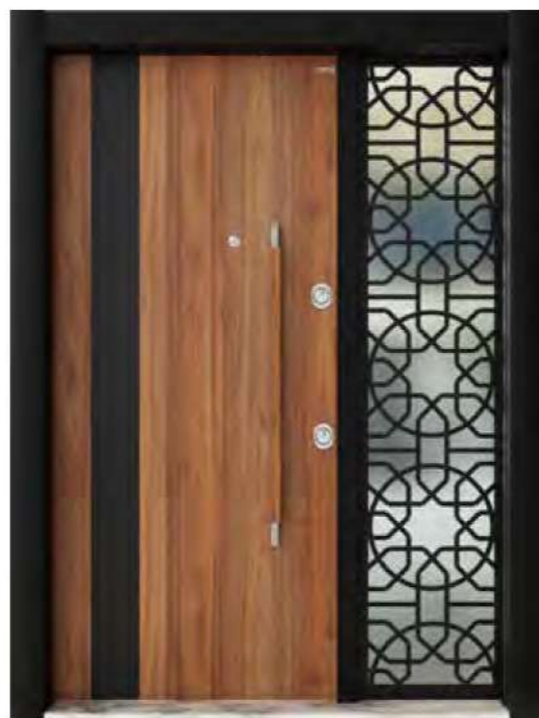

A VL-157

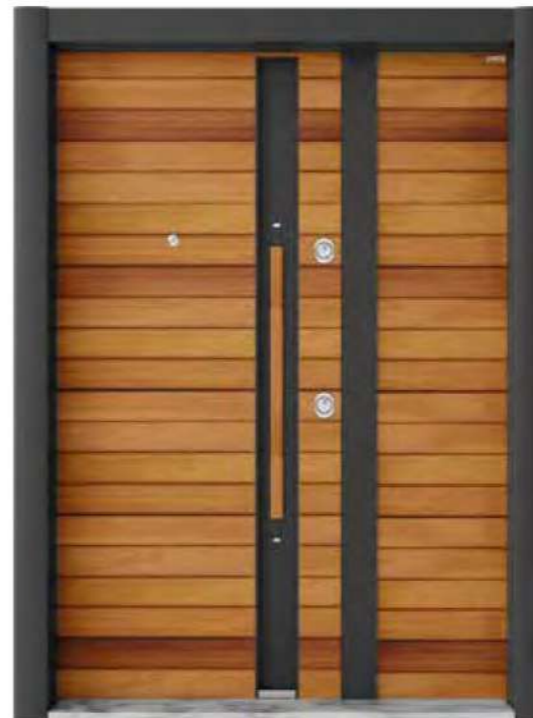

A VL-159



A VL-160

Villa Serisi | Main Entrance Doors

Ayarlı Kasa Adjustable Frame

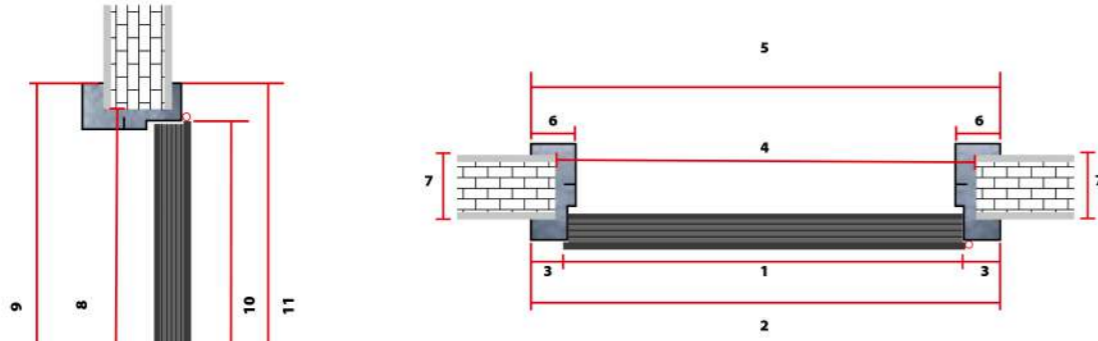

- | | | |
|--|--|--|
| 1 Kasa Boşluğu (En)
Leaf (Wing) Width
87-90-93-97-100-103 cm | 5 Dış Pervaz Bitimi
Exterior Moldings Border
104-107-110-114-117-120 cm | 9 Dış Üst Pervaz Bitimi
Overall Height (Exterior Moldings)
205-208-211-215-218-221 cm |
| 2 İç Pervaz Bitimi (En)
Interior Moldings Border (width)
104-107-110-114-117-120 cm | 6 Dış Pervaz Bitimi
Exterior Moldings
10 cm | 10 Kanat Boşluğu (Yükseklik)
Leaf (Wing) Height
197-200-203-207-210-213 cm |
| 3 İç Pervaz Genişliği
Interior Moldings Border
8,5 cm | 7 Duvar Kalınlığı
Wall Thickness
15-20 cm/ 20-25 cm/ 25-30 cm | 11 İç Üst Pervaz Bitimi
Overall Height (Interior Moldings)
205-208-211-215-218-221 cm |
| 4 Duvar Boşluk (En)
Wall Gap (Width)
94-97-100-104-107-110 cm | 8 Duvar Boşluk (Boy)
Wall Gap (height)
200-203-206-210-213-216 cm | |

İtalyan Kasa Italian Frame

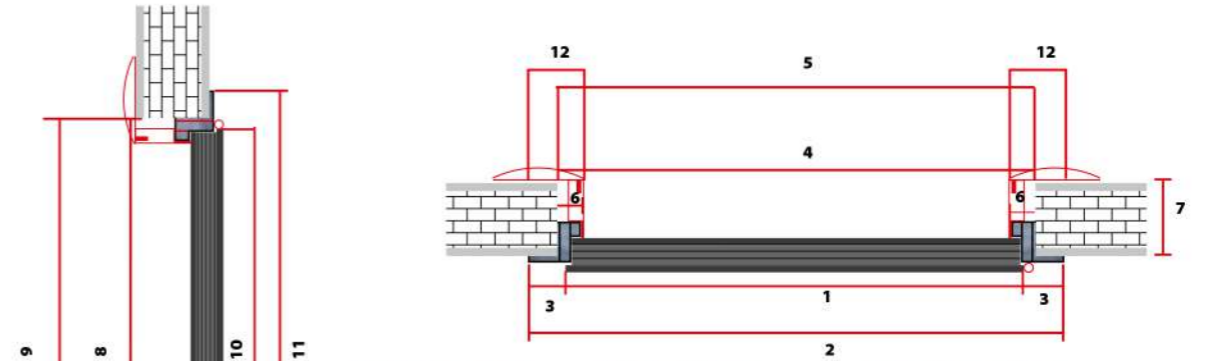

- | | | |
|--|--|--|
| 1 Kasa Boşluğu (En)
Leaf (Wing) Width
87-90-93-97-100-103 cm | 5 Dış Pervaz Bitimi
Exterior Moldings Border
95-98-101-105-108-111 cm | 9 Dış Üst Pervaz Bitimi
Overall Height (Exterior Moldings)
201-204-207-211-214-217 cm |
| 2 İç Pervaz Bitimi (En)
Interior Moldings Border (width)
104-107-110-114-117-120 cm | 6 Dış Pervaz Bitimi
Exterior Moldings
6 cm | 10 Kanat Boşluğu (Yükseklik)
Leaf (Wing) Height
197-200-203-207-210-213 cm |
| 3 İç Pervaz Genişliği
Interior Moldings Border
8,5 cm | 7 Duvar Kalınlığı
Wall Thickness
18-20 cm/ 20-22 cm/ 22-24 cm | 11 İç Üst Pervaz Bitimi
Overall Height (Interior Moldings)
205-208-211-215-218-221 cm |
| 4 Duvar Boşluk (En)
Wall Gap (Width)
97-100-104-107-110-113 cm | 8 Duvar Boşluk (Boy)
Wall Gap (height)
202-205-208-212-215-218 cm | 12 Dış Ahşap Pervaz
Exterior Wood Moldings
12 cm |

Corner Kasa Corner Frame

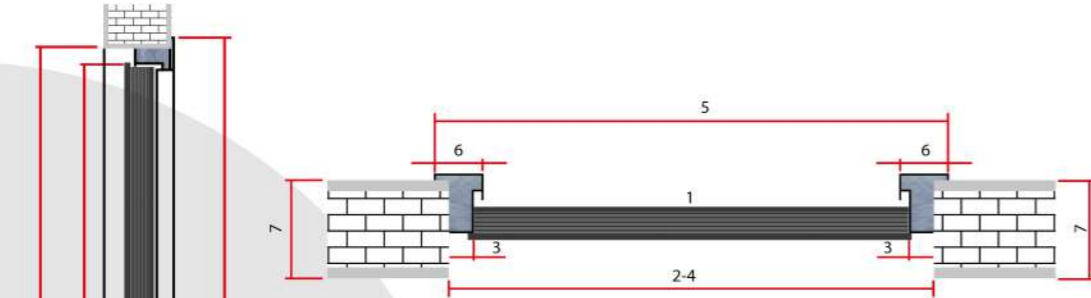

- | | | |
|--|--|--|
| 1 Kasa Boşluğu (En)
Leaf (Wing) Width
87-90-93-97-100-103 cm | 5 Dış Pervaz Bitimi
Exterior Moldings Border
103-106-109-113-116-119 cm | 9 Dış Üst Pervaz Bitimi
Overall Height (Exterior Moldings)
205-208-211-215-218-221 cm |
| 2 İç Pervaz Bitimi (En)
Interior Moldings Border (width)
95-98-101-105-108-111 cm | 6 Dış Pervaz Bitimi
Exterior Moldings
10 cm | 10 Kanat Boşluğu (Yükseklik)
Leaf (Wing) Height
197-200-203-207-210-213 cm |
| 3 İç Pervaz Genişliği
Interior Moldings Border
5 cm | 7 Duvar Kalınlığı
Wall Thickness
15-20-25-30 cm | 11 İç Üst Pervaz Bitimi
Overall Height (Interior Moldings)
201-204-207-211-214-217 cm |
| 4 Duvar Boşluk (En)
Wall Gap (Width)
97-100-104-107-110-113 cm | 8 Duvar Boşluk (Boy)
Wall Gap (height)
202-205-208-212-215-218 cm | |

Sol Kapı Left Door

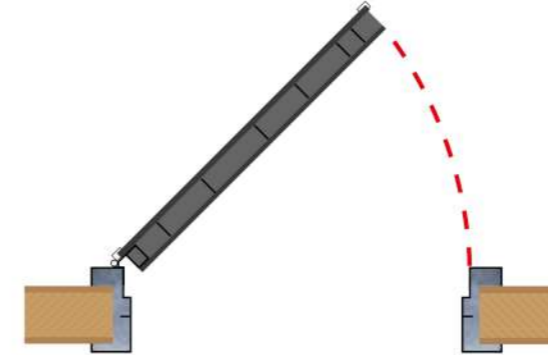

Sağ Kapı Right Door

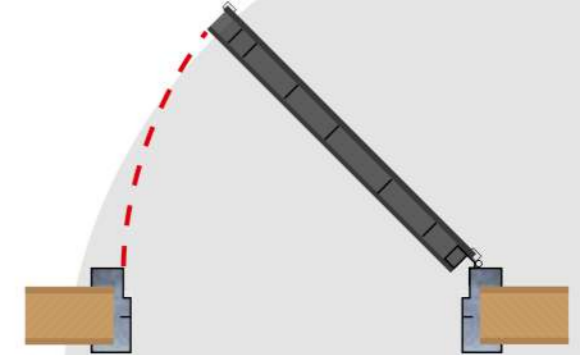

Kilit Sistemleri
Lock Systems



Merkezi Kilit Sistemi
Central Lock System

Yarı Merkezi Kilit Sistemi
Semi Central Lock System

Monoblok Kilit Sistemi
Monoblock Lock System

Kancalı Kilit Sistemi
Hook Lock System

Kanat İç Görünümü
Wing Interior View



- 1 Kanat İç Ahşabı
Internal Wood Of Leaf
- 2 Taş Yünü
Rockwool
- 3 Omurga Destek Sacları
Luxury Leaf Shutter
- 4 Çelik Ana Gövde
Steel Main Body
- 5 Kanat Dış Ahşabı
External Wood Of Leaf



Gizli Emniyet Kilidi
Hidden Security Latch



Lüks Kanat Kesit
Luxury Part Of The Leaf



Dürebün
Peephole



WC Mandalı
WC Latch Lock



Menteşe
Hinge

Kapı Kolları Door Handles



EV - ÇKL - 001
Pull Handle



EV - ÇKL - 002
Pull Handle



EV - ÇKL - 003
Pull Handle



EV - ÇKL - 005
Pull Handle



EV - ÇKL - 007
Pull Handle



EV - ÇKL - 008
Pull Handle



EV - ÇKL - 010
Pull Handle



EV - ÇKL - 011
Pull Handle



EV - ÇKL - 012
Pull Handle



EV - ÇKL - 013
Pull Handle



EV - ÇKL - 014
Pull Handle

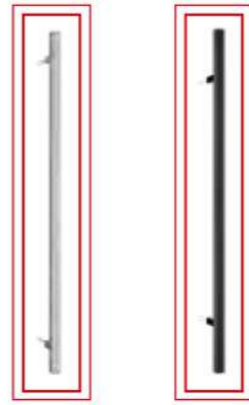

EV - ÇKL - 015 EV - ÇKL - 016
Pull Handle Pull Handle



EV - RK - 013
Lever Handle



EV - RK - 014
Lever Handle



EV - RK - 015
Lever Handle



EV - RK - 016
Lever Handle

Kilit Sistemi Lock Systems



EV - KLT - 001
Monoblok

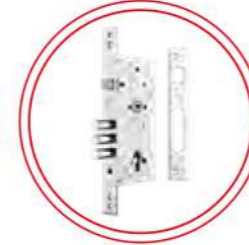

EV - KLT - 002
Kancalı



EV - KLT - 003
Yarı Merkezi
Half Central

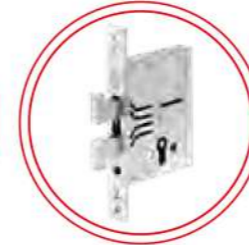

EV - KLT - 004
Merkezi Kilit
Central Lock



EV - KLT - 003
Yarı Merkezi
Half Central



EV - KLT - 004
Merkezi Kilit
Central Lock

Anahtarlar Keys



EV - A - 001
Sistem Barel



EV - A - 002
German Barel



EV - A - 003
Bilyalı Mandallı Barel



EV - A - 004
Bilyalı Barel



EV - A - 005
German Mandallı Barel

Diğer Aksesuarlar Other Accessories



EV - DA - 001
Door Knocker



EV - DA - 002
Door Knocker



EV - DA - 003
Door Knocker



EV - DA - 004
Door Knocker



EV - DA - 005
Door Viewer (Big)



EV - DA - 006
Door Viewer (Small)



Eng. Nazeer Abu Awwad
sales.jo.birtta@outlook.com
JO: +9620777525876